

## 980nm Detachable Fiber LD Module with Aiming Beam

K98D14C-2.00W-FS K98D14C-3.00-FS K98D14C-4.00W-FS K98D14C-5.00W-FS  
K98D14C-7.50W-FS

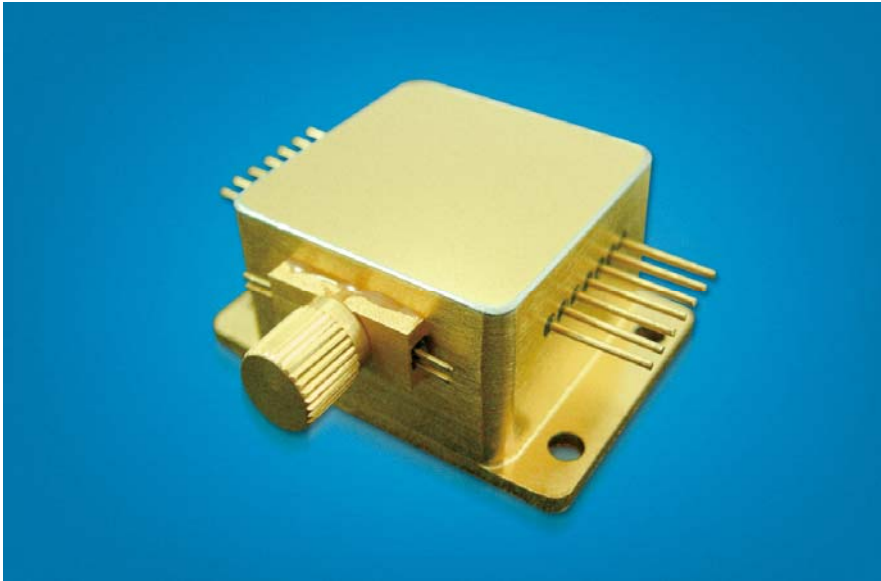

### Key Features:

- ◆ 2-7.5W output power
- ◆ Detachable output
- ◆ 980nm wavelength
- ◆ 650nm aiming beam
- ◆ Customer option:
  - I .Fiber sensor
  - II .Constant power control circuit inside.

### Applications:

- ◆ Laser pumping
- ◆ Medical use
- ◆ Material processing

BWT Beijing's High Power Diode Laser Modules are manufactured by adopting specialized fiber-coupling techniques, resulting in volume products with a high efficiency, stability and superior beam quality. The products are achieved by transforming the asymmetric radiation from the laser diode chip into an output fiber with small core diameter by using special micro optics. Inspecting and burn-in procedures in every aspect come to a result to guarantee each product with the reliability, stability and long lifetime.

Our research staffs are constantly improving and innovating the processing technology in the producing process, based on the professional knowledge and experience accumulated in long-terms. We are also continuously developing new products to meet customers' specific needs.

At BWT Beijing, to provide high quality products with reasonable price is our always goal.

## 980nm Detachable Fiber LD Module with Aiming Beam

K98D14C-2.00W-FS K98D14C-3.00W-FS K98D14C-4.00W-FS K98D14C-5.00W-FS  
K98D14C-7.50W-FS

Specifications (25°C)		Symbol	Unit	K98D14	K98D14	K98D14	K98D14	K98D14
				C-2.00W -FS	C-3.00W -FS	C-4.00W -FS	C-5.00W -FS	C-7.50W -FS
Optical data	CW-output power	$P_o$	W	2	3	4	5	7.5
	Center wavelength	$\lambda_c$	nm	980				
	Tolerance of $\lambda$	-	nm	$\pm 3, \pm 5, \pm 10$				
	Spectral width (FWHM)	$\Delta\lambda$	nm	<3				
	Temperature drift of $\lambda$	-	nm/°C	~0.3				
Connector data	Designed for fiber core diameter	$W_c$	$\mu\text{m}$	200				
	Designed for fiber numerical aperture	NA	-	0.22				
	Fiber connector	-	-	SMA-905				
Electrical data	Operation current	$I_{op}$	A	3.0	4.5	5.5	6.8	11.0
	Threshold current	$I_{th}$	A	0.3	0.5	0.5	0.5	1.2
	Conversion efficiency <sup>1</sup>	$\eta$	%	35~45				
	Slope efficiency <sup>2</sup>	$\eta_D$	W/A	0.8~1.0				
	Operation voltage	$V_{op}$	V	1.6	1.8	1.9	1.9	2.0
	Reverse voltage	$V_{re}$	V	2				
PD data	Current	$I_{mo}$	mA	0.20~2.00				
TEC data	Max. current	$I_t$	A	4.0				
	Max. voltage	$V_t$	V	9.8				
Thermistor data <sup>3</sup>	Thermistor	$R_t$	(K $\Omega$ )/ $\beta$ (25°C)	$10 \pm 5\% / 3477$				
Aiming beam data	Output power	$P_a$	mW	>2				
	Wavelength	$\lambda_a$	nm	$650 \pm 10$				
	Voltage	$V_a$	V	2.2				
	Current	$I_a$	mA	<30				
Other specifications	Operation temperature	$T_{op}$	°C	10~30				
	Storage temperature	$T_{st}$	°C	-20~80				
	Expected lifetime	MTBF	h	>10,000				
	Dimensions (fiber and connector not included)	-	mm	~32×45×19				
	Weight	-	g	~70				
	Lead soldering temperature	$T_{is}$	°C	260(10 sec.)				

1..  $\eta = P_o / (I_{op} V_{op})$ .

2.  $\eta_D = P_o / (I_{op} - I_{th})$ .

3.  $R_t = R_0 \cdot \exp(\beta(1/T - 1/T_0))$ , ( $T_0 = 25^\circ\text{C} = 298\text{K}$ ).

## 980nm Detachable Fiber LD Module with Aiming Beam

K98D14C-2.00W-FS K98D14C-3.00-FS K98D14C-4.00W-FS K98D14C-5.00W-FS  
K98D14C-7.50W-FS

### LD Characteristics

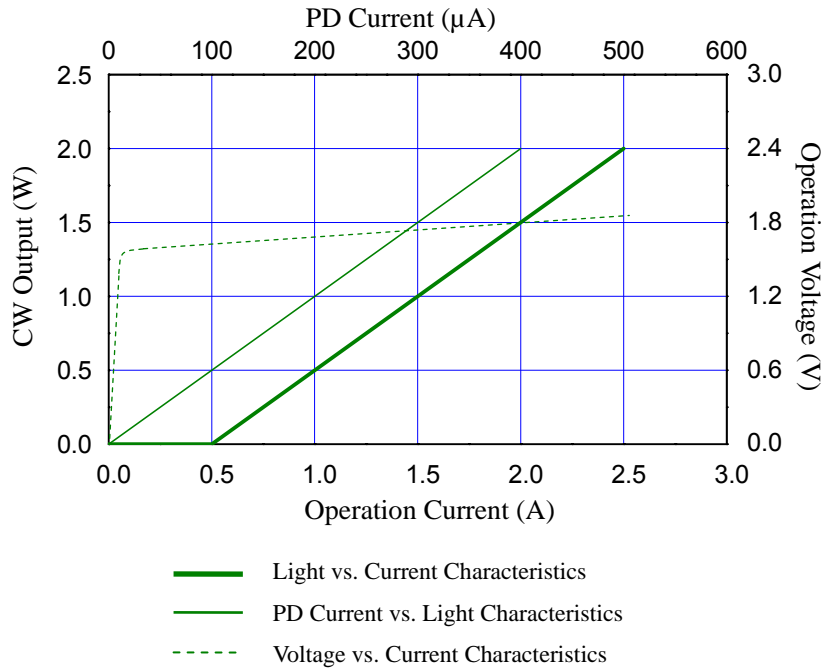

### 650nm LD Light vs. Current Characteristics

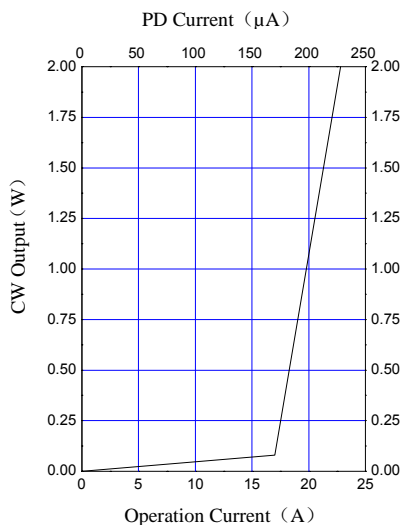

### Typ. spectrum (T=25°C)

Typ. spectrum of 980nm diode laser modules

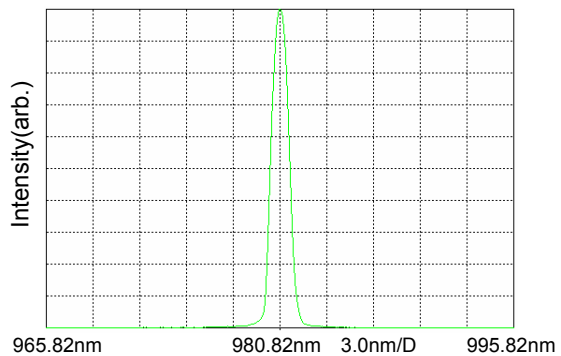

## 980nm Detachable Fiber LD Module with Aiming Beam

K98D14C-2.00W-FS K98D14C-3.00-FS K98D14C-4.00W-FS K98D14C-5.00W-FS  
K98D14C-7.50W-FS

### Package Dimensions(1) (mm) (With Fiber Connector Detector)

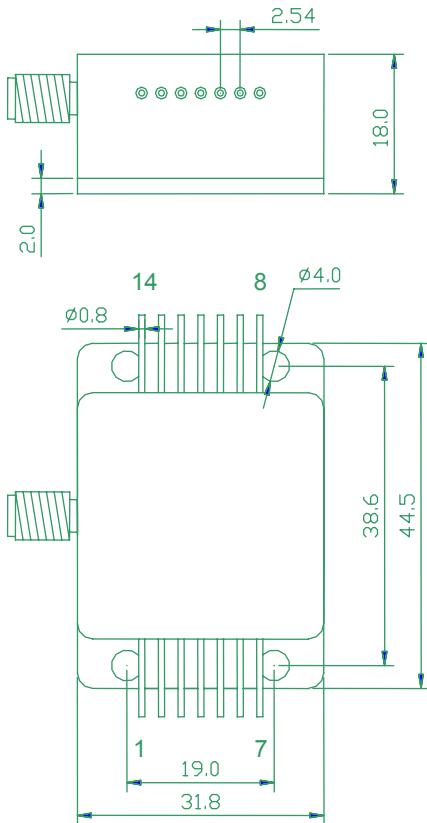

Fiber Connector Detector

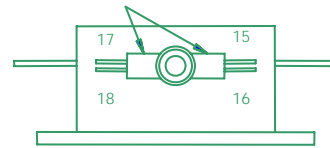

When using this connector, the terminal diameter of connector should be  $> \phi 1.2\text{mm}$ , if the terminal diameter  $< \phi 1.2\text{mm}$ , optical power will be affected.

Pin	Function	Pin	Function
1	Case	8	TEC (-)
2	Laser Anode (+)	9	None
3	Thermistor(1)	10	None
4	Thermistor(2)	11	None
5	Laser Cathode (-)	12	Aiming Beam LD (+) (input 5v +)
6	PD (P)	13	Aiming Beam LD (-) (input 5v -)
7	PD (N)	14	TEC (+)

Fiber Sensor	
Pin	Function
15	LED Cathode(-)
16	LED Anode(+)
17	PD (P)
18	PD (N)

## 980nm Detachable Fiber LD Module with Aiming Beam

K98D14C-2.00W-FS K98D14C-3.00-FS K98D14C-4.00W-FS K98D14C-5.00W-FS  
K98D14C-7.50W-FS

### OPERATING NOTES

- Avoid eye exposure to direct or scattered radiation when the device is in operation.
- ESD precautions must be taken when handling unit.
- Using constant power supplies to guarantee the component works under the limits of its maximum peak optical power.
- The laser diode must be used under specification.
- Unit requires a condition to spread the heat as well as possible.
- Keep the fiber end clean before use. Fiber is not allowed to be curved so much. The diameter of curvature should be 300 times greater than fiber diameter.
- Environment temperature is 10°C--30°C.
- Storage temperature is -20°C--80°C, short circuit store.

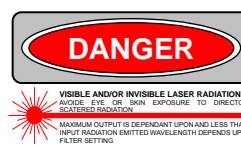

Information and specifications contained herein are deemed to be reliable and accurate. BWT Beijing reserves the right to change, alter or modify the design and specifications of these products at any time with out notice.