

915nm 20W Fiber Coupled Diode Laser

K915FA2RN-20.00W

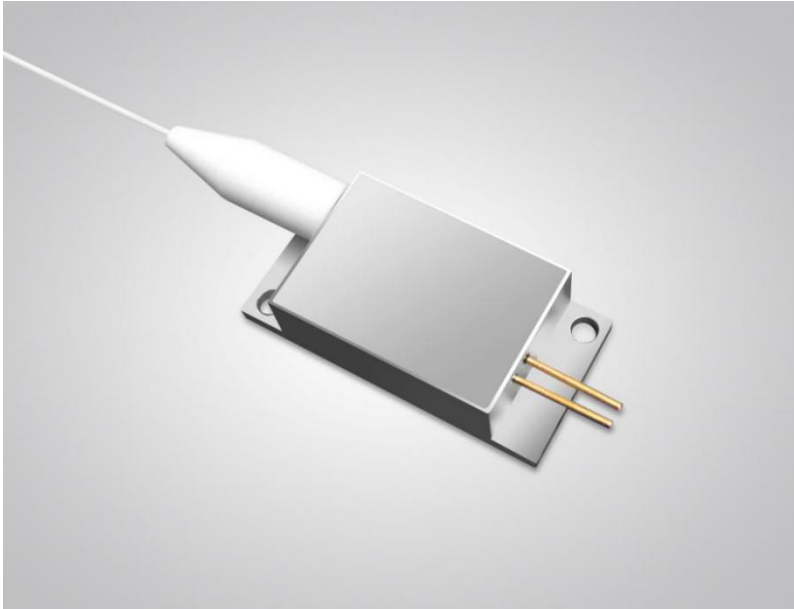

Features:

- ◆ 915nm wavelength
- ◆ 20W output power
- ◆ 105 μ m fiber core diameter
- ◆ 0.22N.A.
- ◆ 1040nm-1200nm feedback protection

Applications:

- ◆ Laser pumping
- ◆ Medical Use
- ◆ Material Processing

BWT Beijing's high power diode laser modules are manufactured by adopting specialized fiber-coupling techniques, resulting in volume products with a high efficiency, stability and superior beam quality. The products are achieved by transforming the asymmetric radiation from the laser diode chip into an output fiber with small core diameter by using special micro optics. Inspecting and burn-in procedures in every aspect come to a result to guarantee each product with the reliability, stability and long lifetime.

Our research staffs are constantly improving and innovating the processing technology in the producing process, based on the professional knowledge and experience accumulated in long-terms. We are also continuously developing new products to meet customers' specific needs.

At BWT Beijing, to provide high quality products with reasonable price is our always goal.

915nm 20W Fiber Coupled Diode Laser

K915FA2RN-20.00W

Specifications(25°C)		Symbol	Unit	K915FA2RN-20.00W		
				Minimum	Typical	Maximum
Parameter ⁽¹⁾	CW Output Power	P _O	W	20	-	-
	Threshold current	I _{th}	A	-	1	-
	Operating current	I _{op}	A	-	11.5	14
	Operating voltage	V _{op}	V	-	-	4
	Reverse Voltage	V _{re}	V	-	5	-
	Slope Efficiency	η	W/A	-	2	-
	Electrical-to-Optical Efficiency	PE	%	-	48	-
	Center wavelength	λ _c	nm	905	-	925
	Spectral width(FWHM)	δλ	nm	-	6	-
	Back reflection wavelength Range	λ	nm	1040	-	1200
	Back reflection isolation	-	dB	-	30	-
	Wavelength Shift with Temperature	-	nm/°C	-	0.3	-
	Light within 0.15NA	NA	-	-	95	-
	Life Time	MTTF	hrs	-	100000	-
Fiber Date	Buffer diameter	D _{buf}	μm	-	250	-
	Cladding diameter	D _{clad}	μm	-	125	-
	Core diameter	D _{core}	μm	-	105	-
	Numeric aperture	NA	-	-	0.22	-
	Fiber length ⁽²⁾	l _f	m	-	1	-
	Fiber Bend Radius	-	mm	37.5	-	-
Others	ESD	V _{esd}	V	-	-	500
	Storage temperature	T _{stg}	°C	-20	-	70
	Lead Soldering Temp	T _{ls}	°C	-	-	260
	Lead Soldering Time	t	sec	-	-	10
	Operating case temperature	T _{op}	°C	15	-	35
	Relative Humidity	RH	%	15	-	75

(1) Data measured under operation output at 20W.

(2) Other fibers available upon request.

915nm 20W Fiber Coupled Diode Laser

K915FA2RN-20.00W

Characteristics

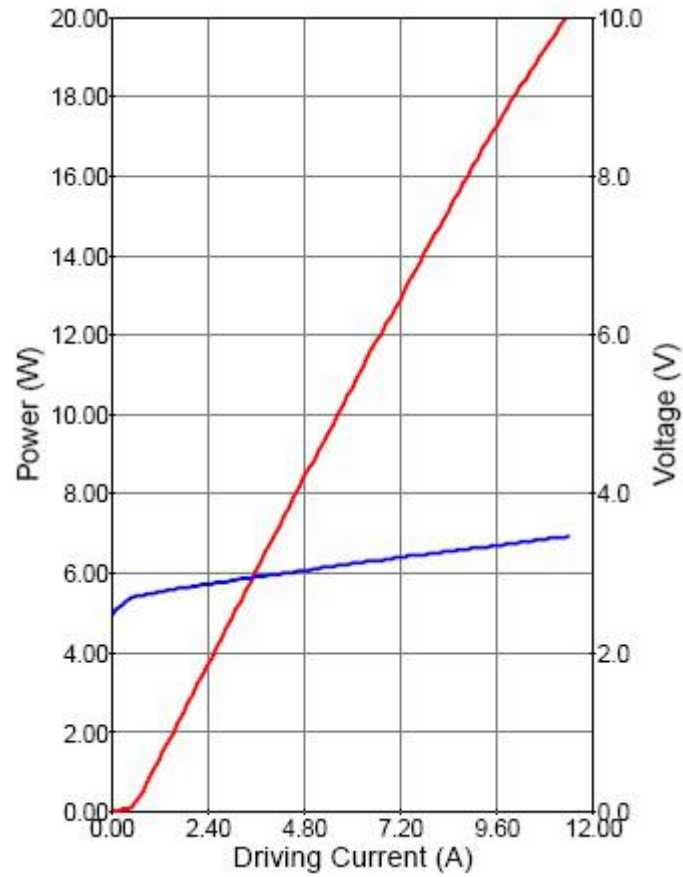

915nm 20W Fiber Coupled Diode Laser K915FA2RN-20.00W

Package Dimensions (mm)

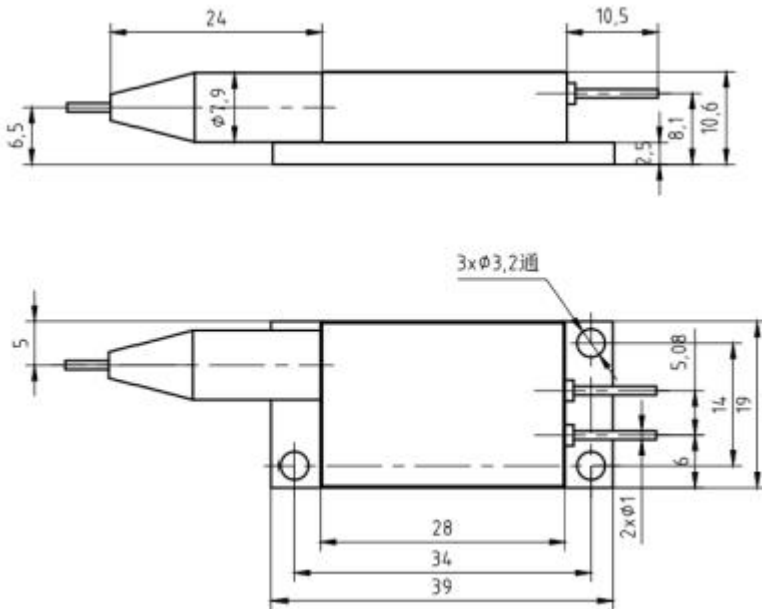

Pins	Function
1	LD (+)
2	LD (-)

OPERATING NOTES

- ◆ Avoid eye exposure to direct or scattered radiation.
- ◆ ESD precautions must be taken.
- ◆ Please connect pins to wires by solder instead of using socket when operation current is higher than 6A.
- ◆ Soldering point should be close to the root of the pins. Soldering temperature should be lower than 260°C and time shorter than 10 second.
- ◆ Use constant current power supply. Avoid surge current.
- ◆ Laser diode must be used according to the specifications.
- ◆ Laser diode must work with good cooling.
- ◆ A minimum bend radius should be 300 times greater than the fiber cladding diameter, dynamic bend radius should be 400 times greater than the fiber cladding diameter.
- ◆ Operation temperature is 15°C~ 35°C.
- ◆ Storage: -20°C~ +70°C, all pins short-circuit.



Declaration: information and specifications contained herein are deemed to be reliable and accurate. BWT Beijing reserves the right to change, alter or modify the design and specifications of these products at any time without notice.